

Energy Management Energy Savings Performance Contracting for the school complex Riedlingen

Project Presentation

Darmstadt, September 9th, 2013
Dipl.-Ing. Michael Pietzner

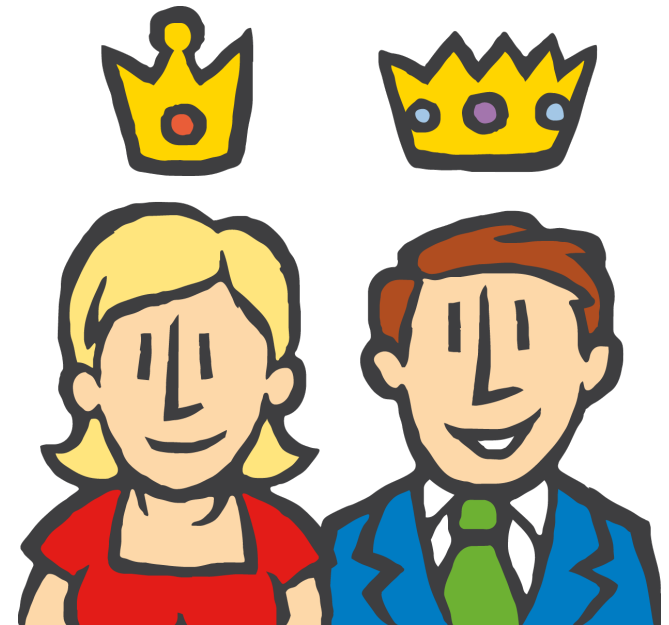

Agenda

Company Presentation

Energy Savings Performance Contracting

The Project

Measurement and Verification: results to date



Company Presentation



Company Presentation

WISAG

Industry Service



Facility Service



Aviation Service



Company Presentation

WISAG Industry Service

Industry Service

- Maintenance
- Technical Cleaning
- Facility Management Industry
- Construction Electrical Systems
- Construction HVAC
- Logistics for Production
- Production Support
- Construction of Industrial Systems

Facility Service



Aviation Service

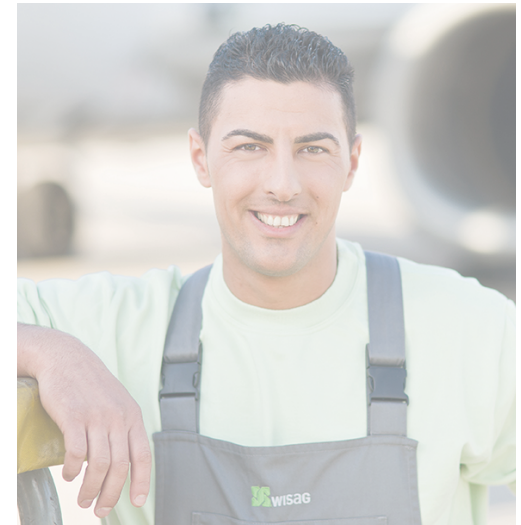

WISAG Energiemanagement

Our Scope of Work

Building Technology

- Heating and Cooling Supply
- HVAC and Cooling Systems
- Lighting
- Water and Waste Water
- Building Automation Technology
- **Energy Management**

- Energy Consulting, Energy Concepts
- Turnkey Projects (Project Development, Consulting Implementation of Energy Savings Measures incl. Financing, if required)
- Guaranteed Savings
- Independent and web based Building Management System
- Development and Implementation of Measurement Concepts plus web based Energy Management System
- Monitoring and Controlling Services
- Implementation of Energy Management Systems in accordance with DIN EN ISO 50001

Our Company References government customers



Landkreis
Neu-Ulm



Landkreis
Nürnberger
Land



Freiburg
IM BREISGAU



Stadt Röthenbach a.d.Pegnitz

FREISTAAT THÜRINGEN
JUSTIZVOLLZUG



Baden-Württemberg



Hansestadt
Lübeck



Wehrbereichsverwaltung
West



Edingen-
Neckarhausen

WIKEN
des Landkreises
WEIßENBURG
GUNZENHAUSEN



Klinik St. Georg

PARK-KLINIK WEISSENSEE
AKADEMISCHES LEHRKRANKENHAUS DER CHARITÉ

- ✓ Optimization of approx. 250 buildings
- ✓ Contract volume approx.. 50 Mio. €
- ✓ Investment in savings measures: approx. 30 Mio. €
- ✓ Guaranteed savings: approx. 5 Mio. € per year

Our Company

References commercial customers



Energy Savings Performance Contracting



Energy Savings Performance Contracting Guaranteed Energy Savings



- Investment in technical systems to improve energy consumption and reduce energy costs
- (re-)financing through guaranteed savings
 - Implementation of savings measures with defined ROI
 - Savings Guarantee for the customer
- Our Services:
 - Consulting, Financing and Project implementation (Turnkey Project)
 - Maintenance
 - Measurement and Verification (Monitoring & Controlling), further Optimization of Energy Consumption

Energy Savings Performance Contracting Contractual Framework

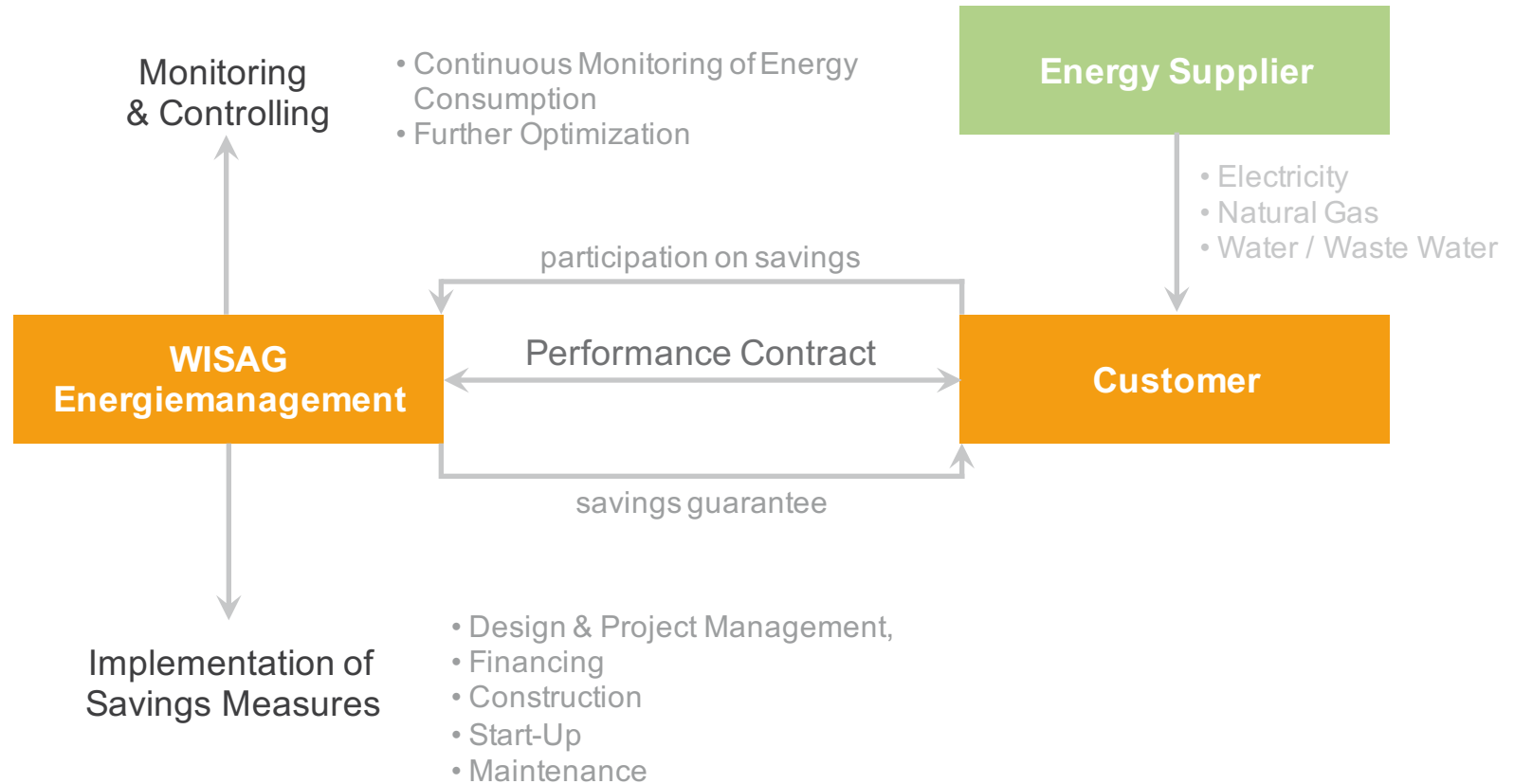

Energy Savings Performance Contracting Financing the investment with guaranteed savings

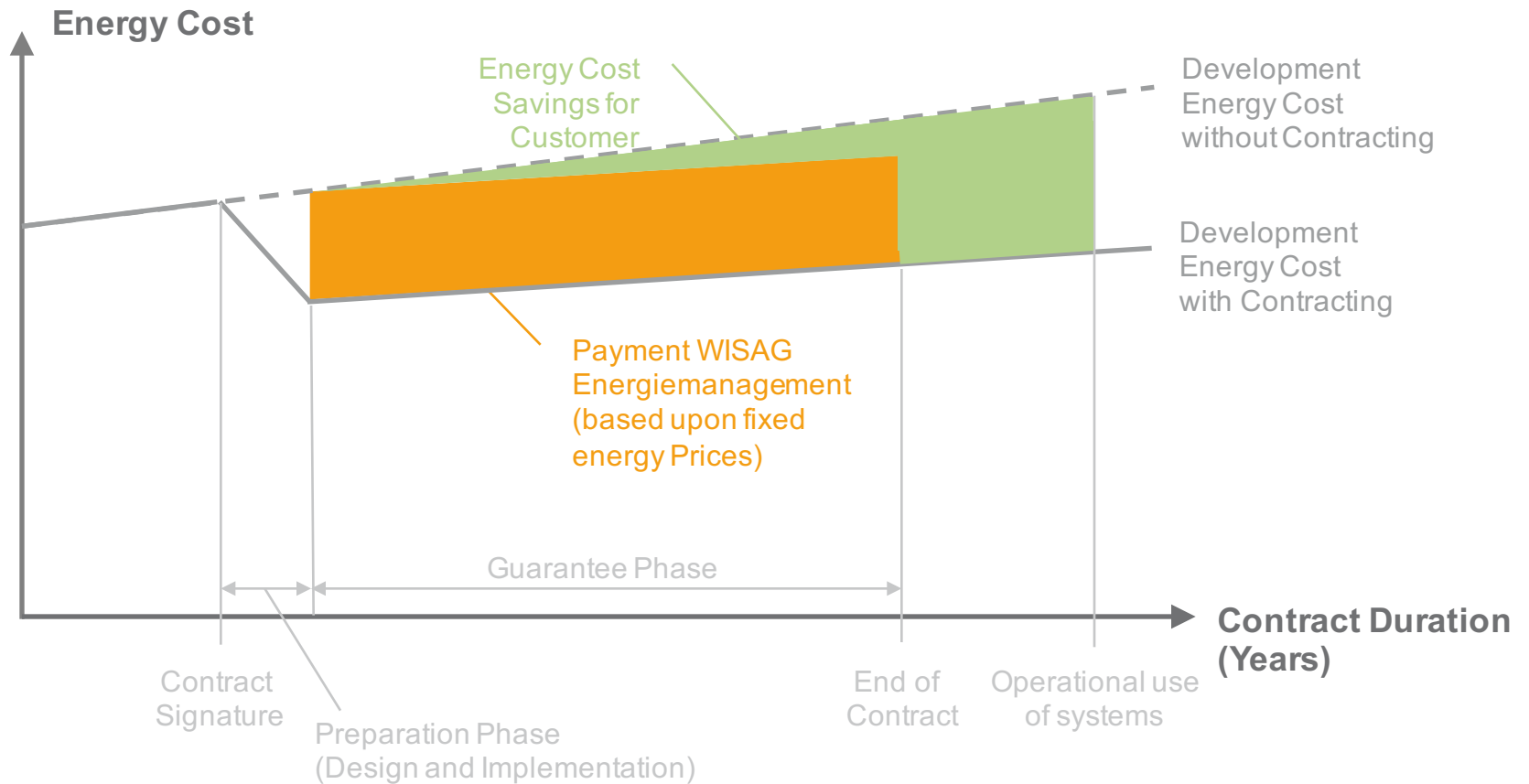

Energy Savings Performance Contracting

Process of project development

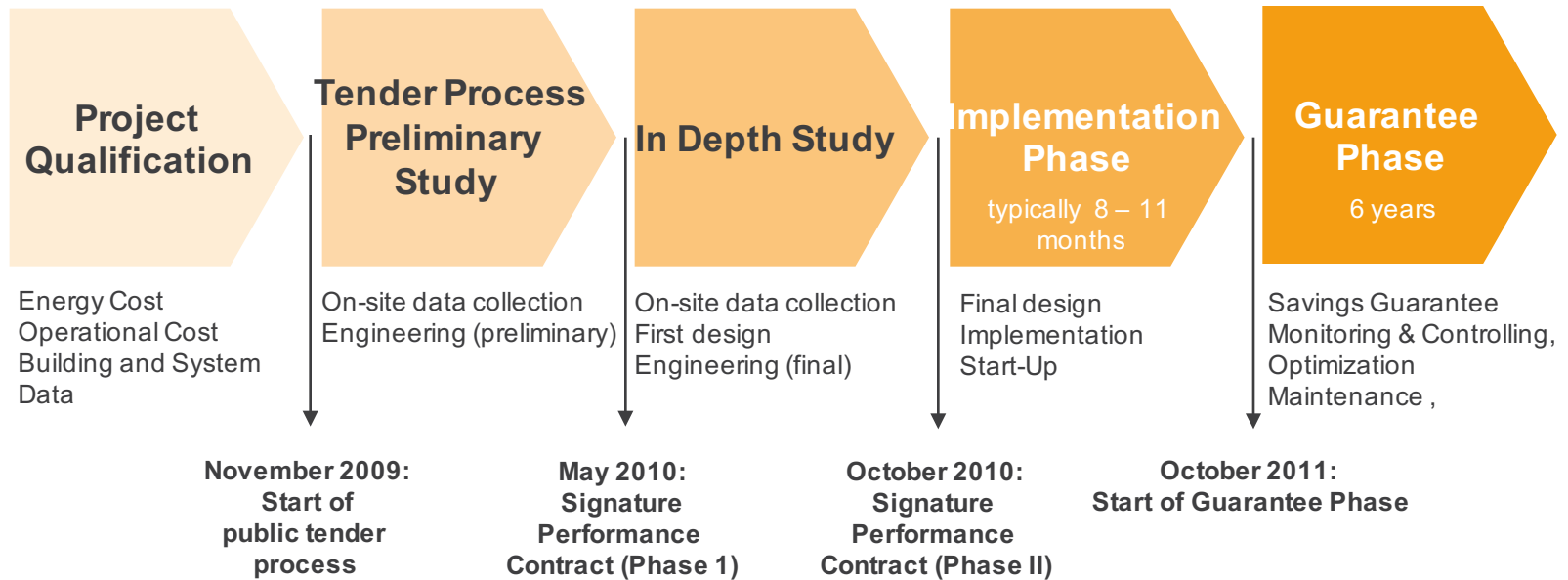

The Project: 2 Schools, each with a gym



The Project Area Map

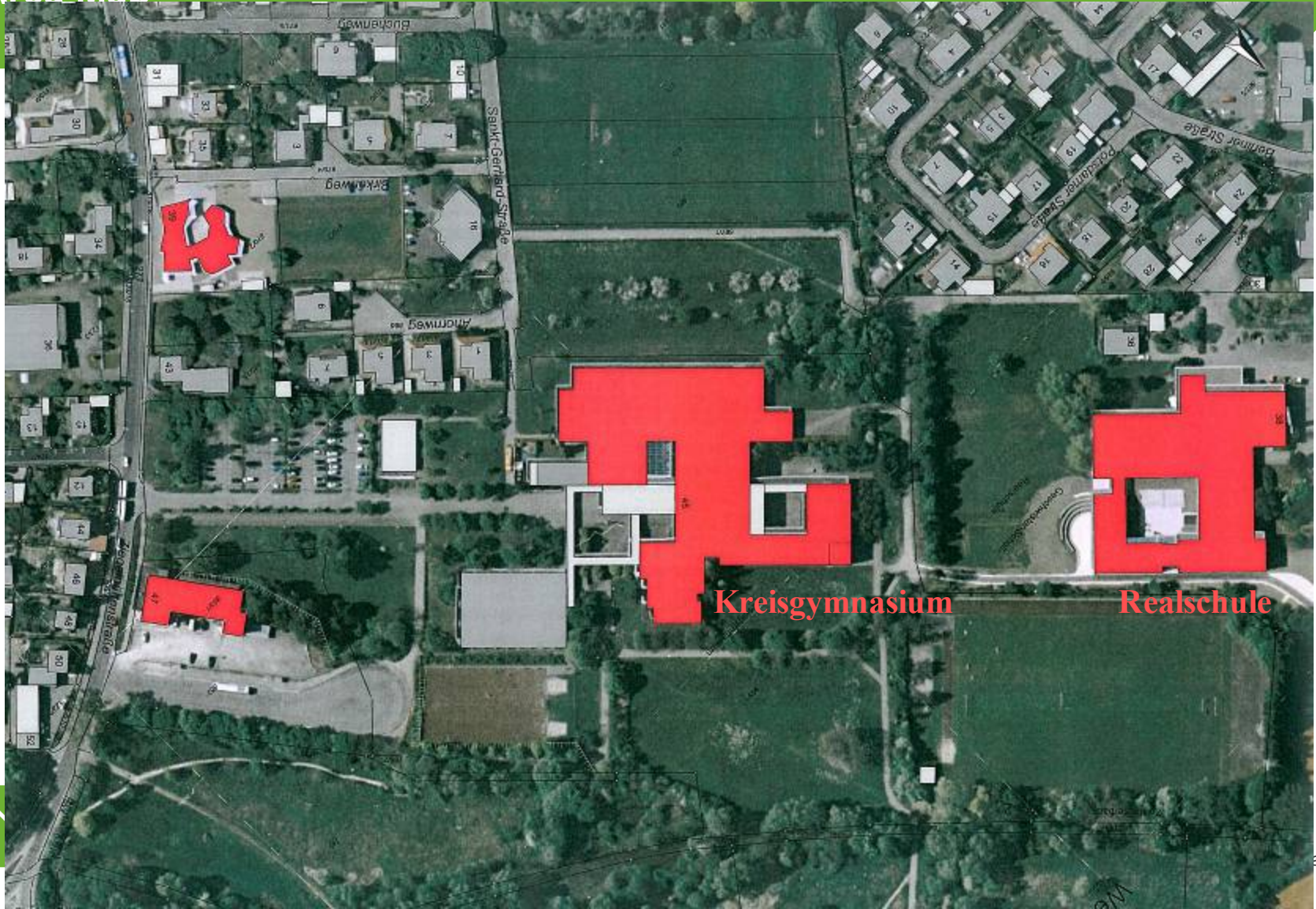

The Project

The Buildings



Kreisgymnasium



Realschule

The Project

On-site Visit: existing technical systems Kreisdgymnasium



The Project

On-site Visit: existing technical systems Kreisgymnasium



The Project

On-site Visit: existing technical systems Realschule

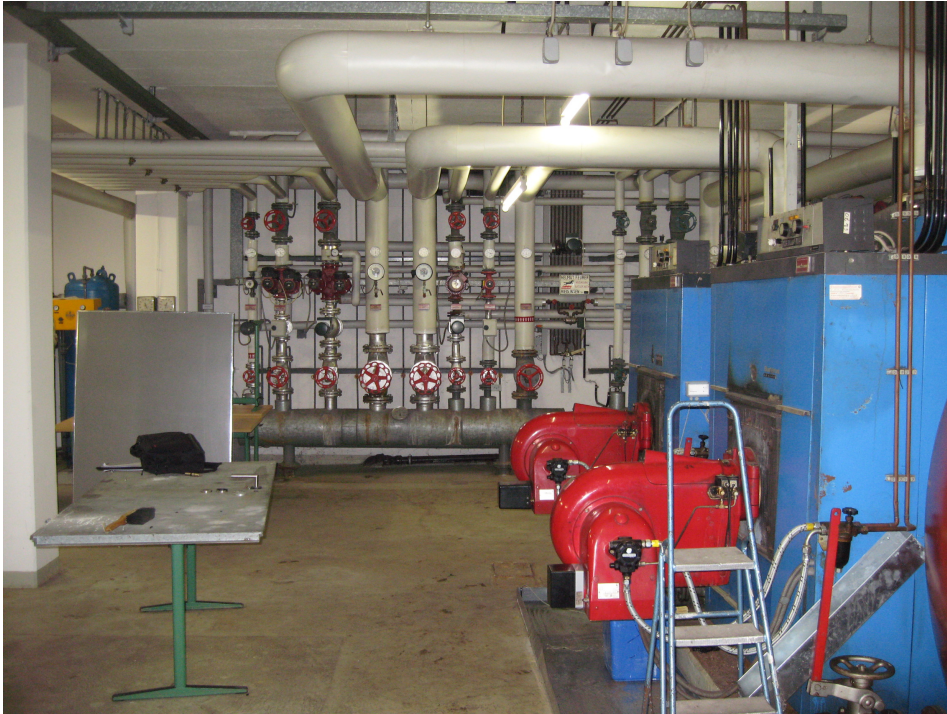

The Project

Energy Cost Baseline

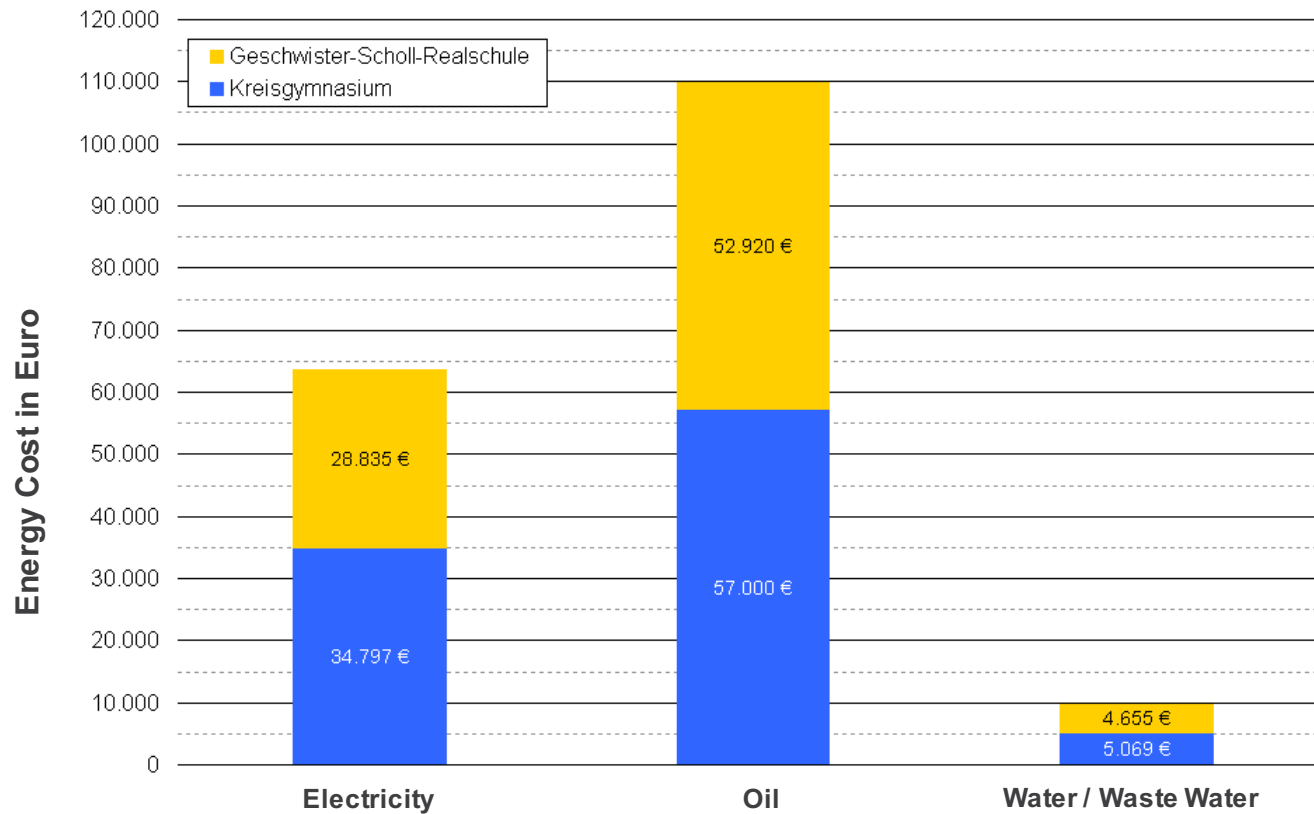

The Project

The Contract



- Signature of contract: October 29th, 2010
- Guarantee Phase: 6 years
- Baseline of energy cost: 183.080 €/a (2008)
- Invest in technical systems: 1.462.520 €
- Guaranteed savings: 138.937 €/a
- Total value of contract: 1.744.919 €
- Start of guarantee phase: October 1st, 2011
- CO₂-Savings: 600 to/a

The Project

Technical Measures Kreisgymnasium

Heating Technology (1)	Heating Technology (2)	Electrical Systems	Lighting	Building Automation System
Continue use of existing oil-fired boiler in central heating plant	Renewal of heating distribution system in central heating plant	Renewal main electrical distribution system and electric panel for central heating plant and heating distribution system	Renewal of 860 lighting panels in all kind of rooms	New DDC-controls for central heating plants
New building for central heating plant with woodchip storage	Implementation of district heating system with Realschule (465 m)	New Transformer (400 kVA) for future supply of both buildings with electricity		Connect all DDC-controls (new and existing) to web based Building Management System (BMS)
Gas fired CHP System (50 kWel, 88 kWth) with water storage tank (6 m³)	Connection of heating distribution system of Sporthalle to main supply system	New power cable to connect new transformer Station with Realschule (380 m)		Implementation of new meters
Woodchip boiler (500 kW) with electrical filter		Installation of Meter for Cogen electricity production		Connect all meters to Energy Management System
Renewal of required equipment for central heating plant operation				

The Project

Technical Measures Geschwister-Scholl-Realschule

Heating Technology (1)	Electrical Systems	Lighting	Building Automation System
Dismantling of existing oil-fired boiler	Renewal main electrical distribution system and electric panel for heating distribution system	Renewal of 460 lighting panels in all kind of rooms	New DDC-controls for central heating plants
Connect heating distribution system to district heating system	Shut-down of existing transformer station		Connect all DDC-controls (new and existing) to web based Building Management System (BMS)
Renewal of required equipment for central heating plant operation	Connect main electrical distribution system to power cable from new transformer station at Kreisgymnasium		Implementation of new meters
			Connect all meters to Energy Management System

The Project

Design Phase: Area Layout Plan



The Project

Design Phase: new building for central heating plant

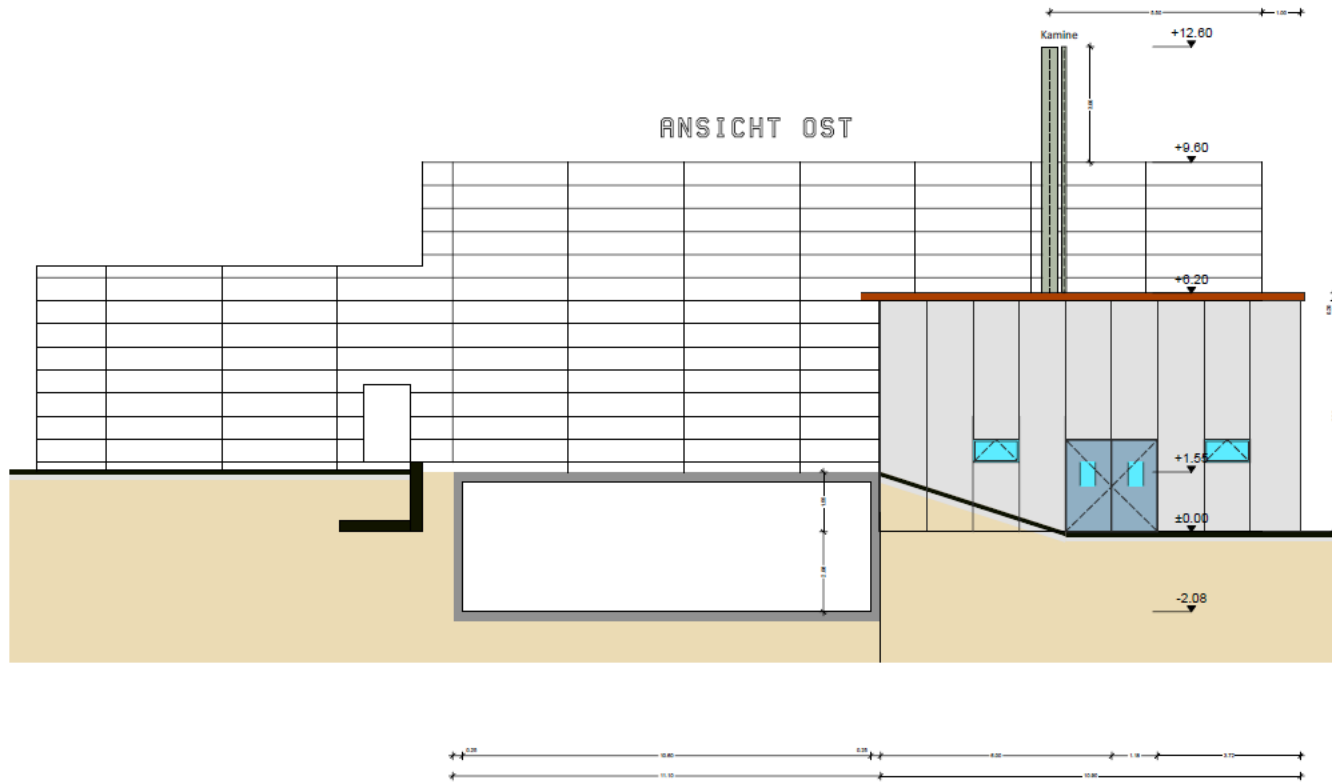

The Project

Design Phase: new building for central heating plant (2)

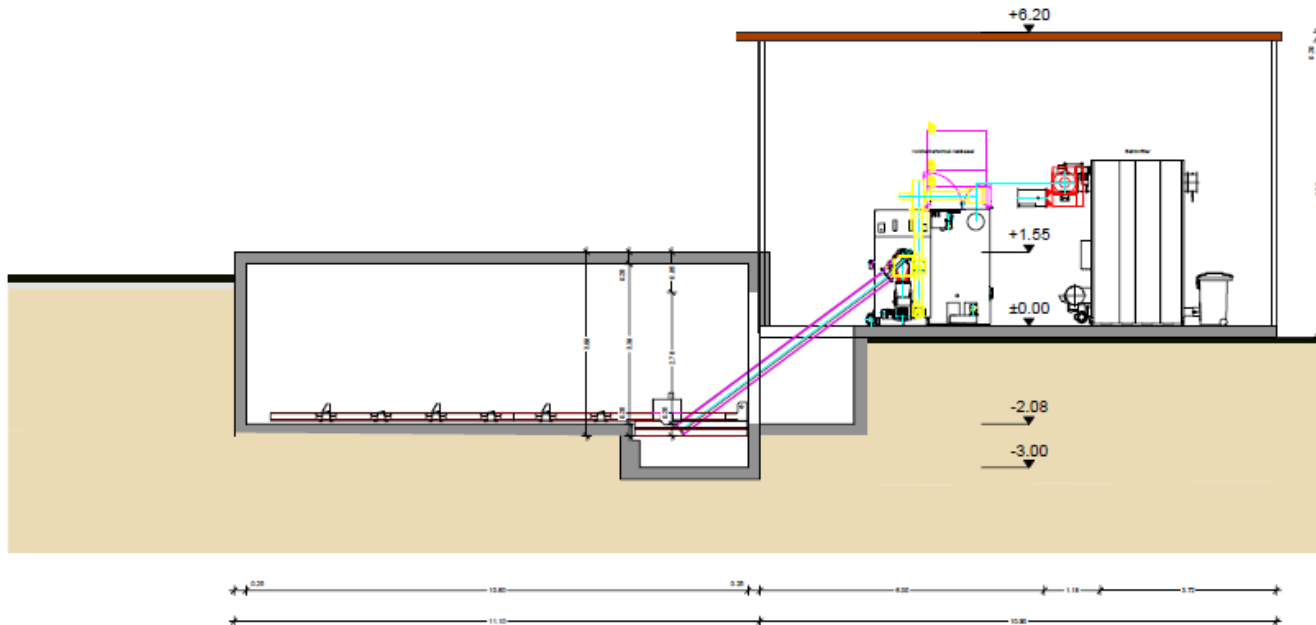

The Project

Design Phase: layout new building

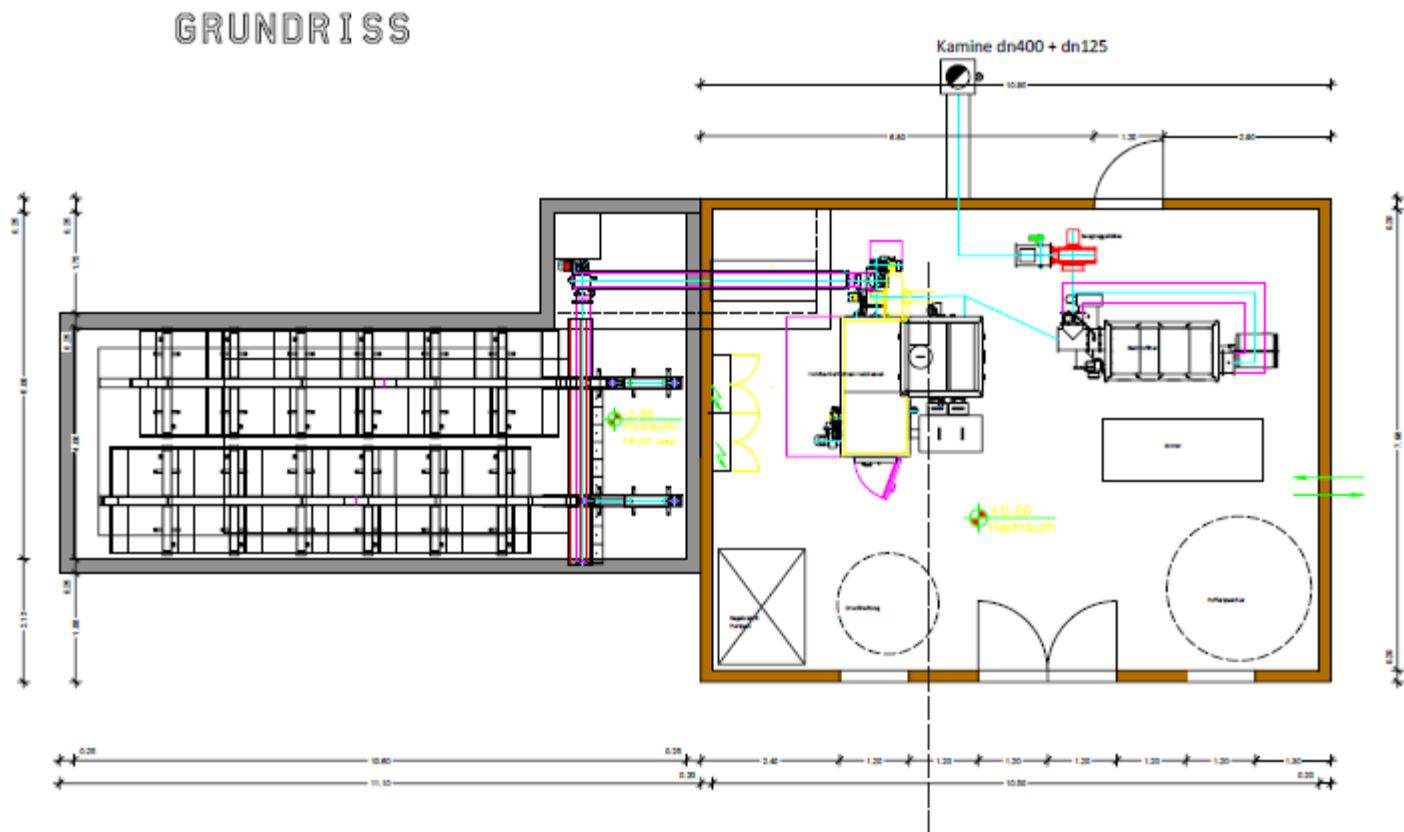

The Project

Design Phase: heating supply and distribution system

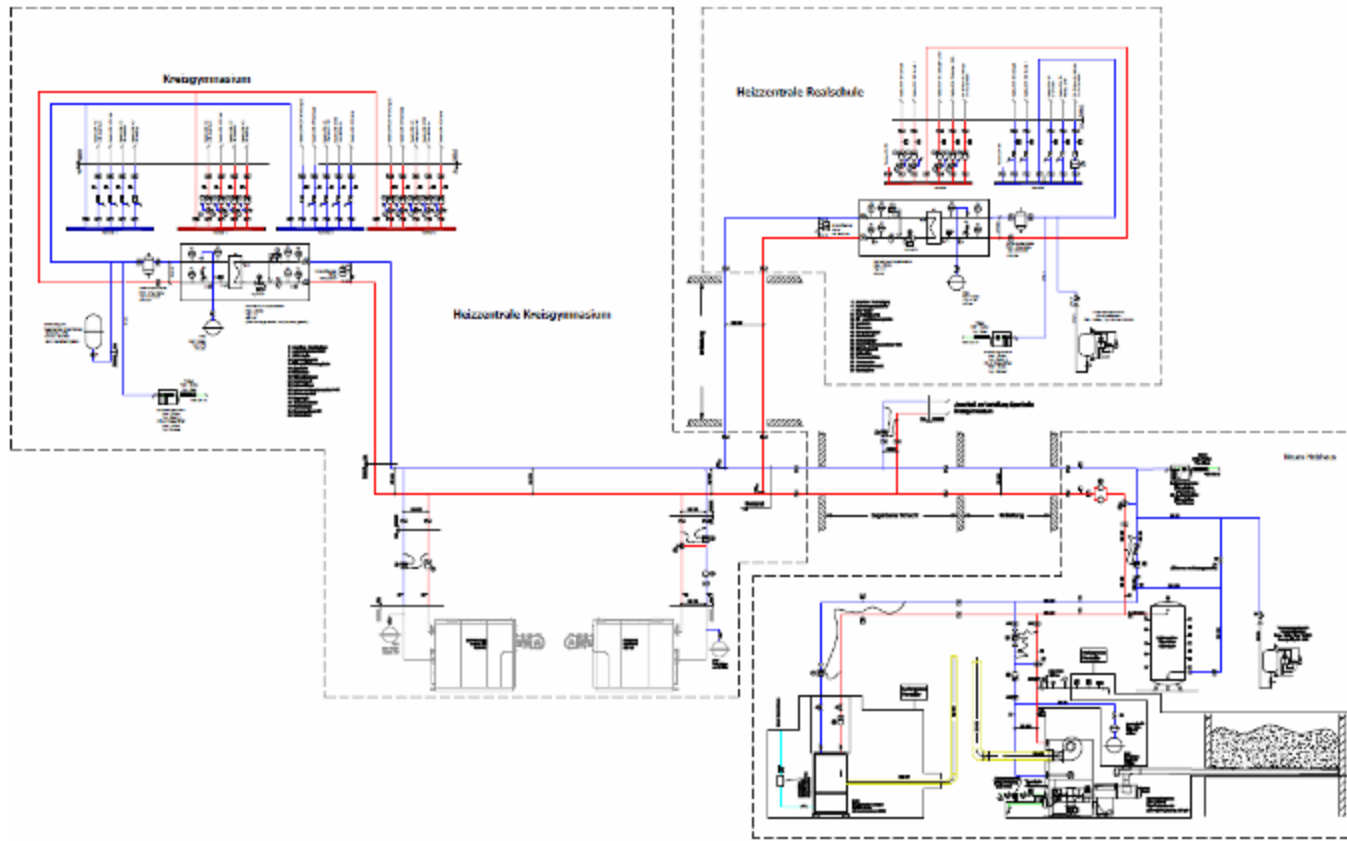

The Project

Implementation Phase: new building for central heating plant



The Project

Implementation Phase: Inside the new central heating plant: woodchip boiler



The Project

Implementation Phase: new transformer and district heating system



Measurement and Verification: results to date



Measurement and Verification

Evaluation baseline oil consumption

Witterungsbereinigter Heizölverbrauch in kWh Hi (letzte 12 Monate)

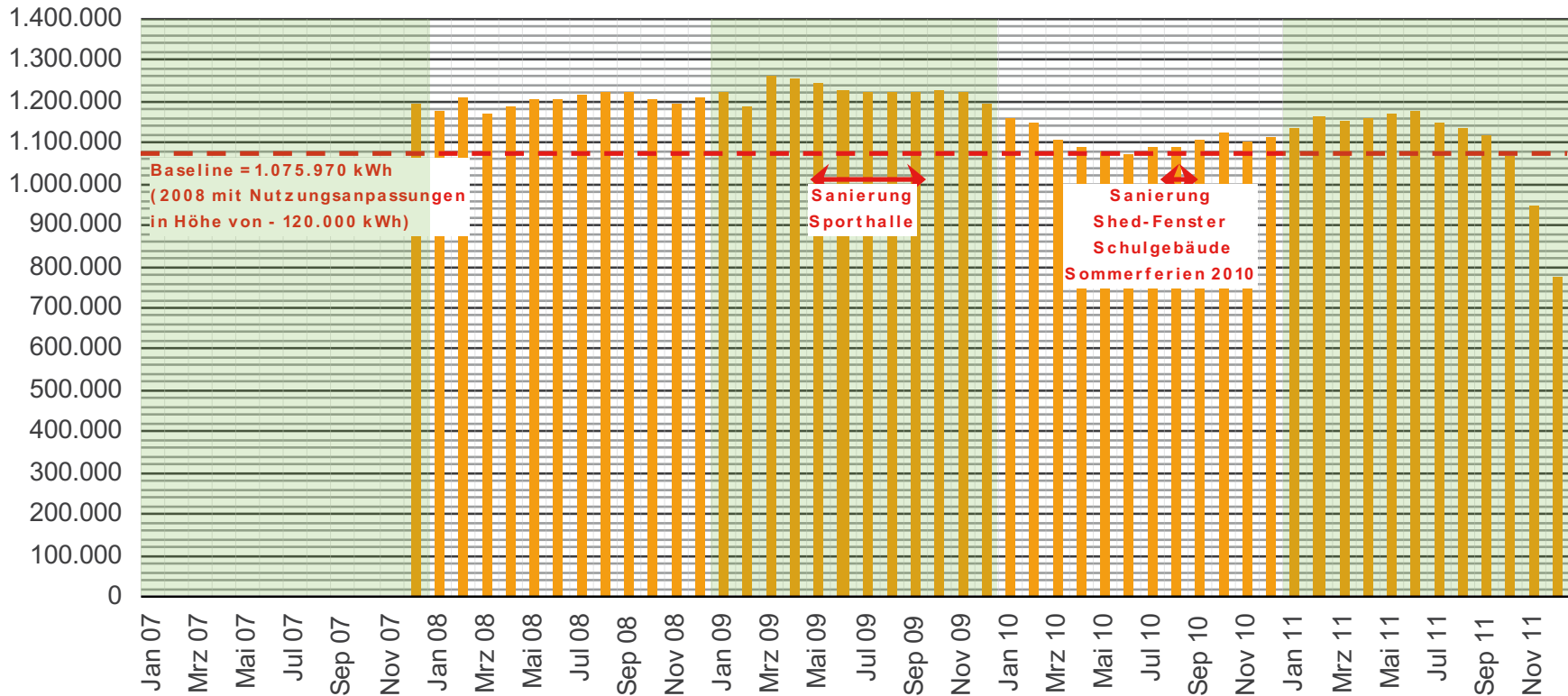

Measurement and Verification

Evaluation metered gas consumption (guarantee phase)

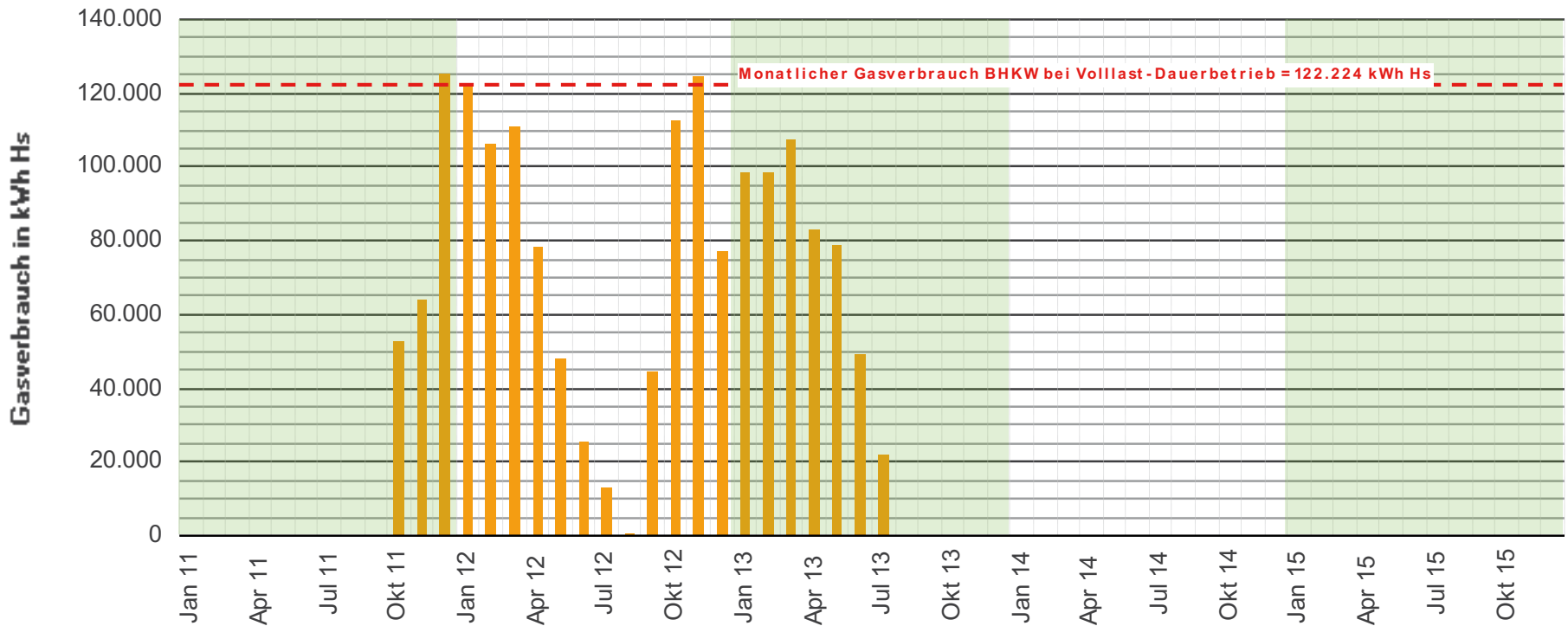

Measurement and Verification

Evaluation heating production, hdd-corrected (guarantee phase)

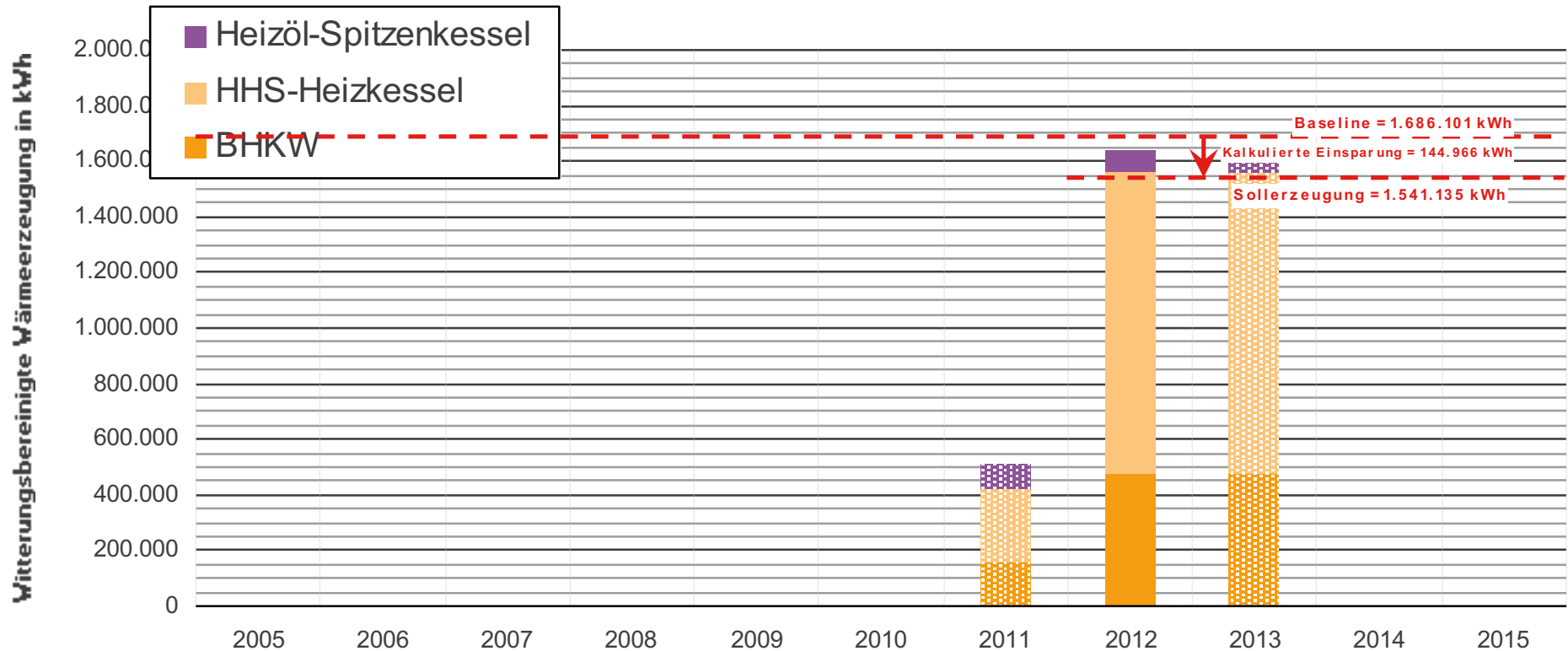

Measurement and Verification

Evaluation heating production (guarantee phase)

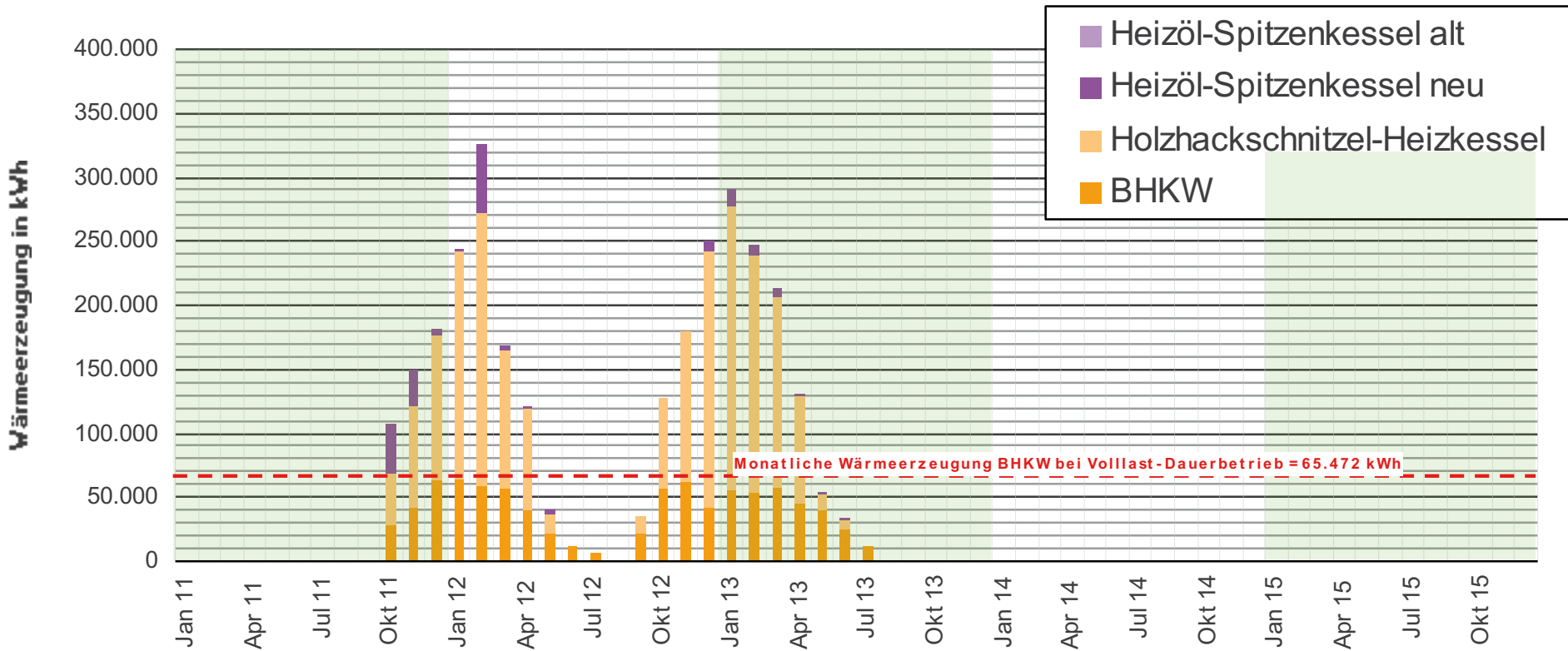

Measurement and Verification

Evaluation heating consumption, hdd-corrected (guarantee phase)

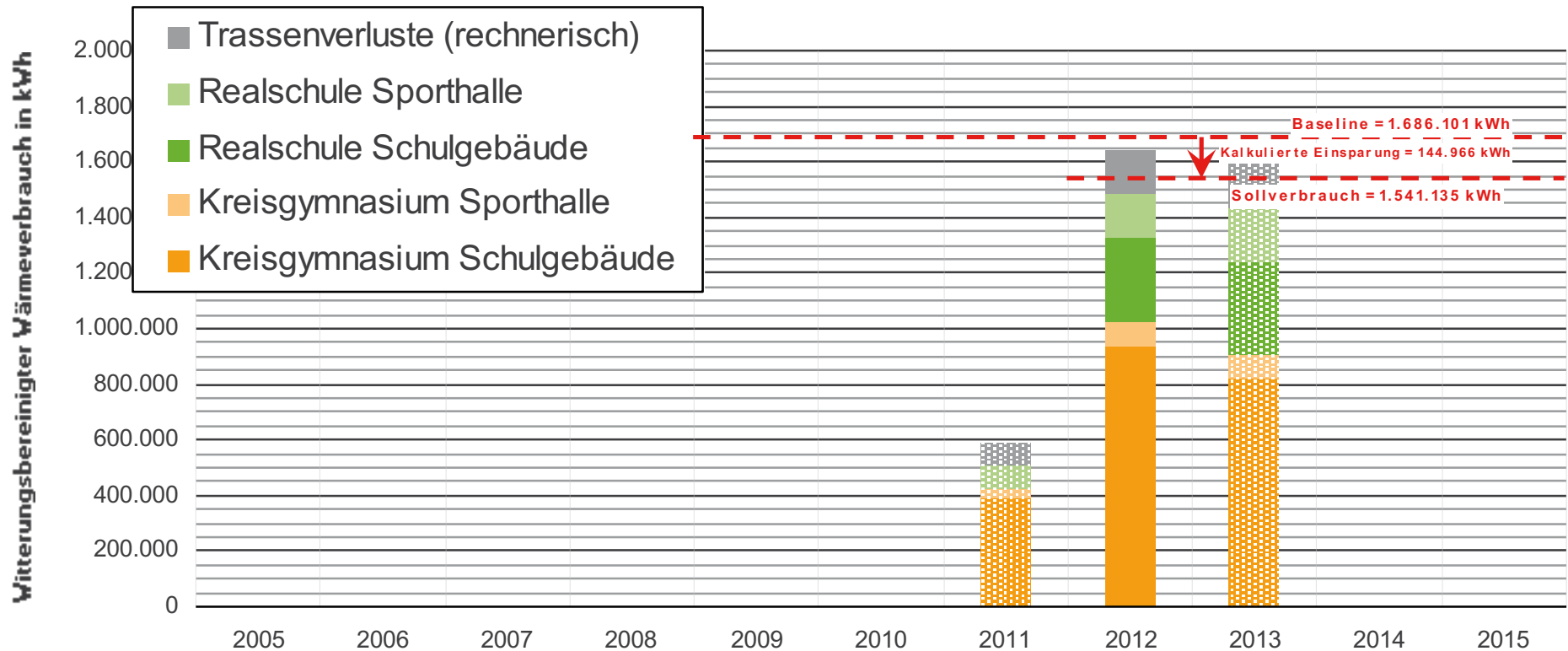

Measurement and Verification

Evaluation electricity production cogen (guarantee phase)

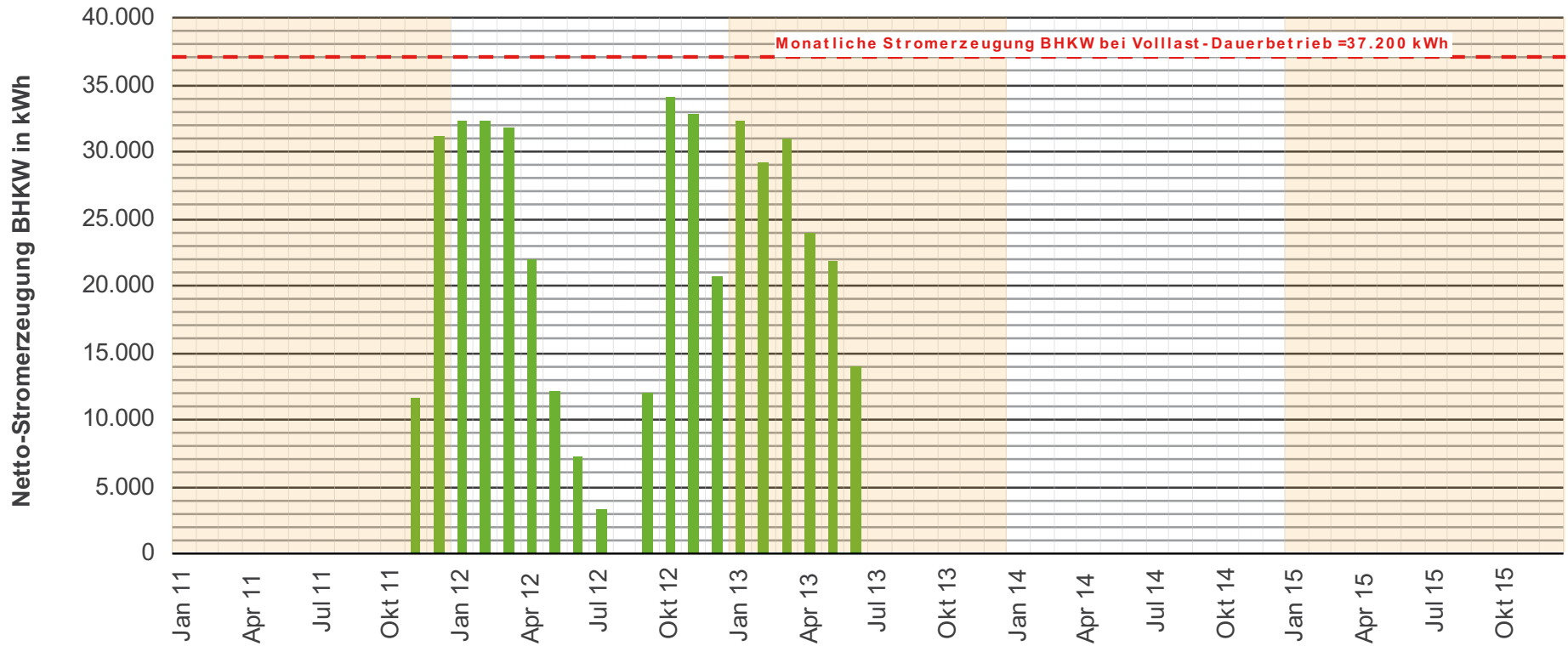

Measurement and Verification

Evaluation electrical efficiency cogen (guarantee phase)

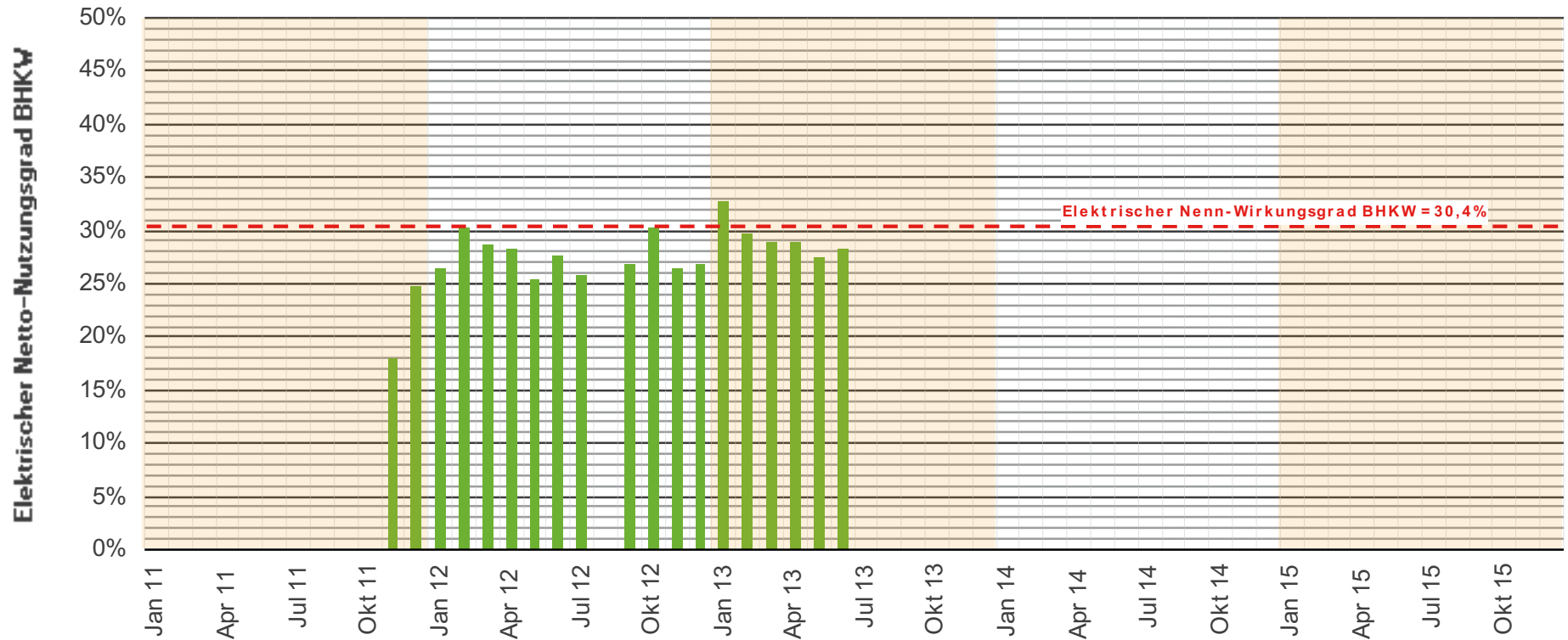

Measurement and Verification

Evaluation thermal efficiency cogen (guarantee phase)

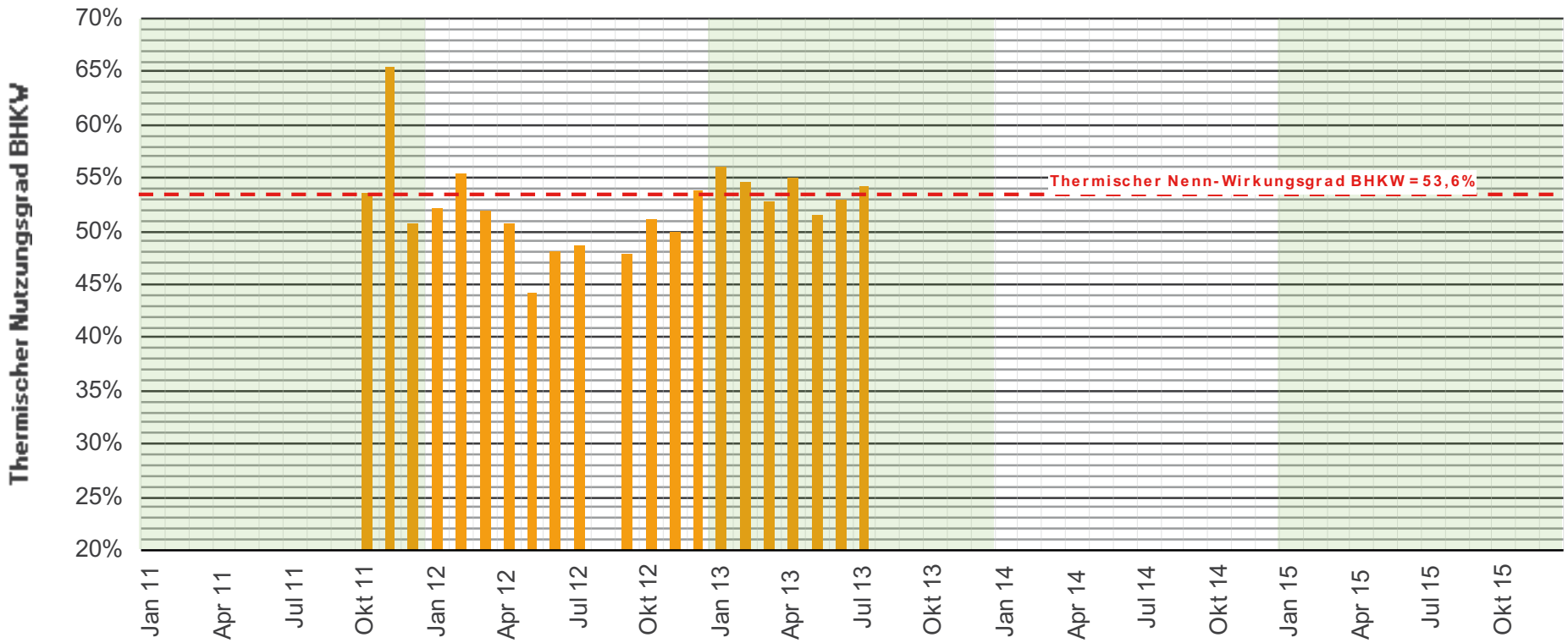

Measurement and Verification

Evaluation electricity consumption (guarantee phase)

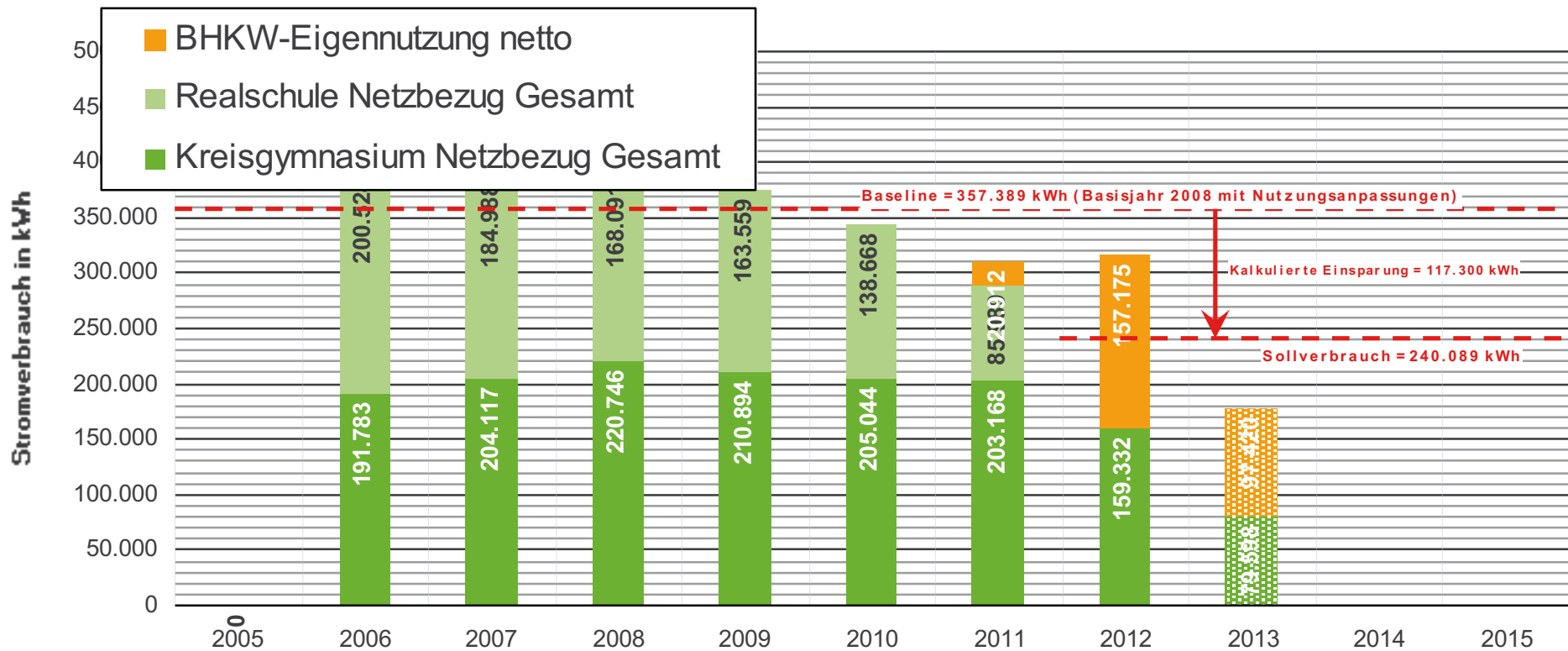

**WISAG Energiemanagement
GmbH & Co. KG**
Michael Pietzner
Zollhausstraße 95
D-90469 Nürnberg
Tel. +49 172 4008843
Fax +49 911 81294-4958
Mail michael.pietzner@wisag.de

www.wisag.de

